



Smart AWC Duo

Manual



Model

SAWC-400P

List of Parts (Can Be Purchased Separately)

Item	Picture	Description
Smart AWC Duo Controller x1		1. Controller with touch panel & two Dual Sensors 2. Max. Mounting Thickness : 1/2 inch (12.7 mm)
Universal Power Adapter x1		Universal Power Supply : 100-240 VAC
DC Pump x3		Head : 8.2 feet (250 cm)
Universal Tube Holder x3		For rimmed and rimless aquariums up to 1/2 inch (12.7 mm)
Siphon Break x3		A connector to break the siphon
Tubing 19.6 feet (600 cm)		Used with DC Pumps



Caution : Risk of Injury from Strong Magnets

Controller & Dual Sensors

■ Smart AWC Duo Controller



- Ⓢ1 : High Level Dual Sensor
- Ⓢ2 : Low Level Dual Sensor
- Ⓜ : Power DC Jack
- Ⓟ1 : ATO Filling Pump/ Freshwater AWC Filling Pump Jack
- Ⓟ2 : AWC Drain Pump Jack
- Ⓟ3 : Saltwater AWC Filling Pump Jack

■ High Level Dual Sensor

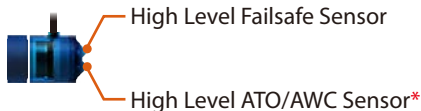

■ Low Level Dual Sensor

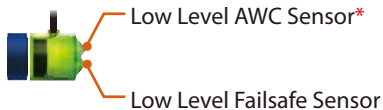

*The High Level ATO/AWC Sensor must be at least 1/4 inch (6 mm) higher than the Low Level AWC Sensor, or Smart AWC Duo will not work properly.

Installation

1. AWC

(Auto Water Change) i. Saltwater Aquarium

Step 1 :

Mount the blue sensor (S1) at normal water level – ATO water level (with the lower sensor indicating the water level) on the tank/sump with the magnet.*

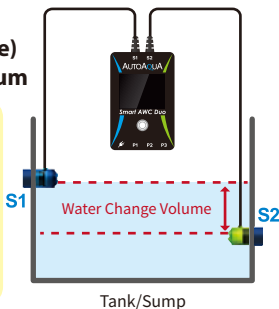

Step 2 :

Mount the green sensor (S2) at low water level (with the top sensor indicating the water level) on the tank/sump with the magnet.*

*Please avoid setting up the sensor in an area with micro bubbles or direct light.

Step 3 :

Connect AWC drain tube (pump ↔ siphon break* ↔ tubing holder).

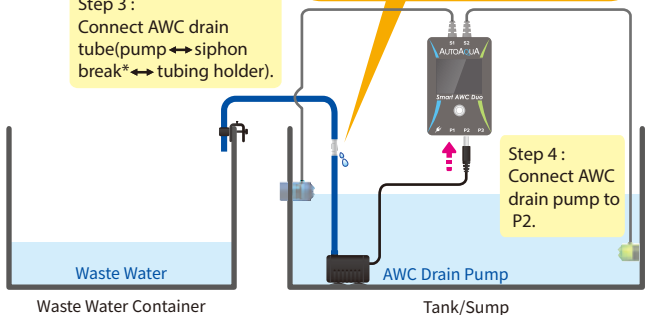

Step 4 :

Connect AWC drain pump to P2.



***Note :** Place siphon break inside the tank/sump but above the water level.

Air In : Siphon break allows air in to break the siphon when the pump turns off.

Water Out : Water drops out of the hole are normal when the pump is on.

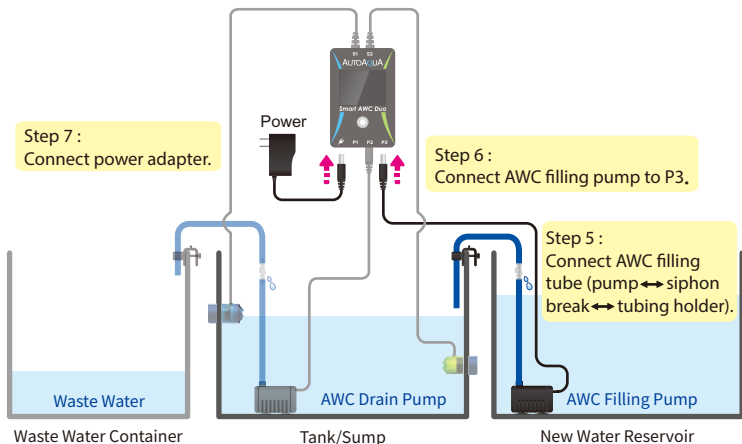

ii. Freshwater Aquarium

For Freshwater aquariums, P3 is not required.

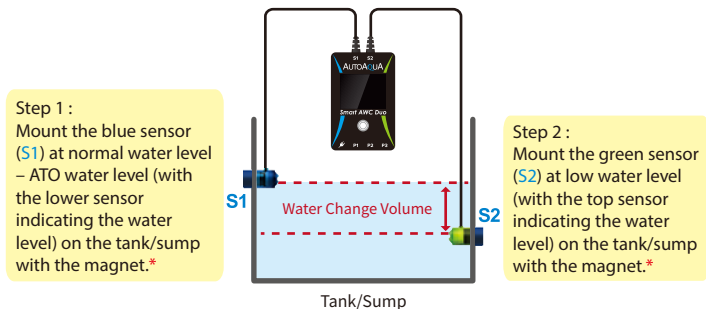

*Please avoid setting up the sensor in an area with micro bubbles or direct light.

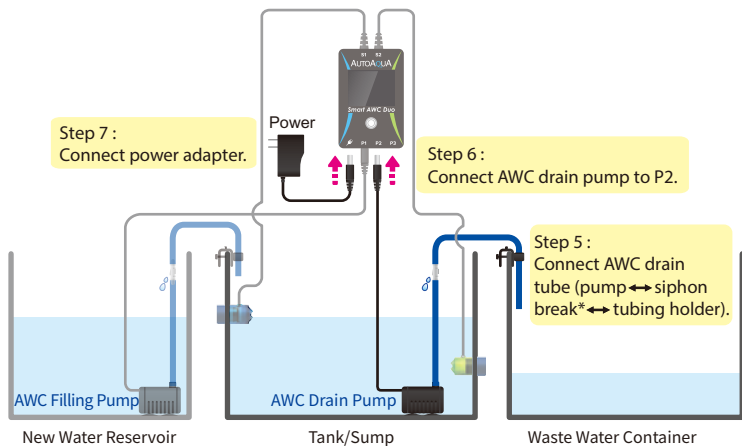
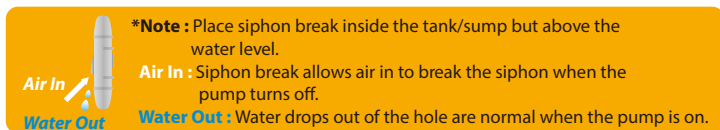
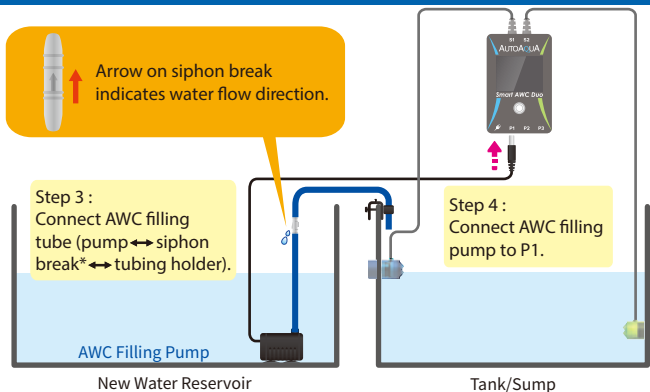

2. ATO (Auto Top Off)

In freshwater mode, ATO operates with pump 1.

Step 1 :
Mount the blue sensor (S1) at normal water level (with the lower sensor indicating the water level) on the tank/sump with the magnet.*

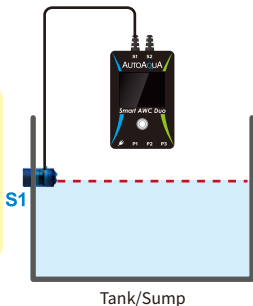

*Please avoid setting up the sensor in an area with micro bubbles or direct light.

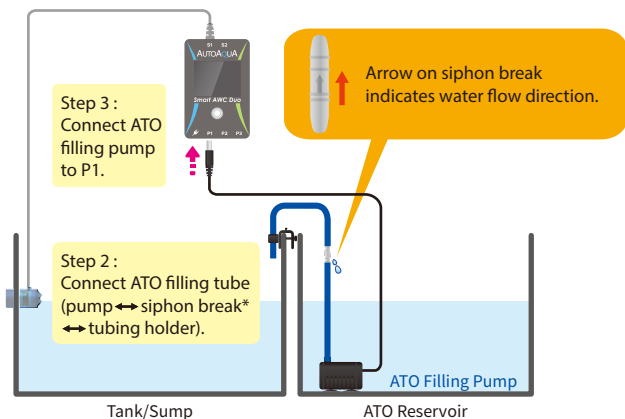

***Note :** Place siphon break inside the tank/sump but above the water level.

Air In : Siphon break allows air in to break the siphon when the pump turns off.

Water Out : Water drops out of the hole are normal when the pump is on.

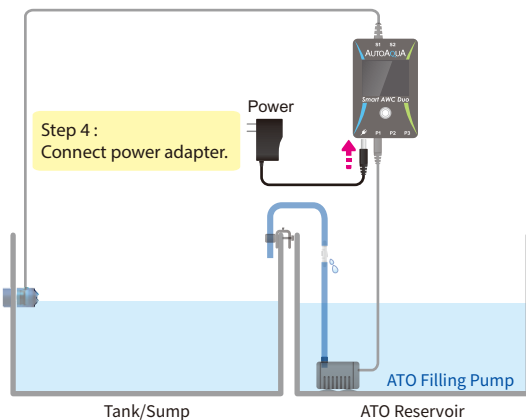

*The DC pumps can be replaced with larger AC pumps with AUTOAQUA Smart AC Switch

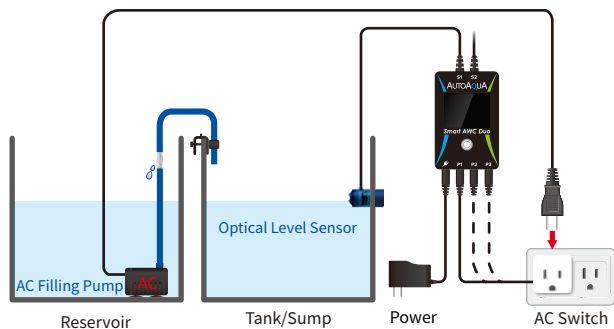

Calculating the Water Change Volume

The volume can be calculated by multiplying the width and length of your tank and the distance between the pyramids of the two sensors.*

For example, a tank is 18 inches in length and 17 inches in width. If the distance between the two sensors is 3 inches, the water change volume is approximately 4 gallons.

$18'' (L) \times 17'' (W) \times 3'' (H) = 918 \text{ cubic inches (around 4 gallons)**}$

* The water volume might be influenced by factors such as the speed of return pump.

**231 cubic inches = 1 US gallon

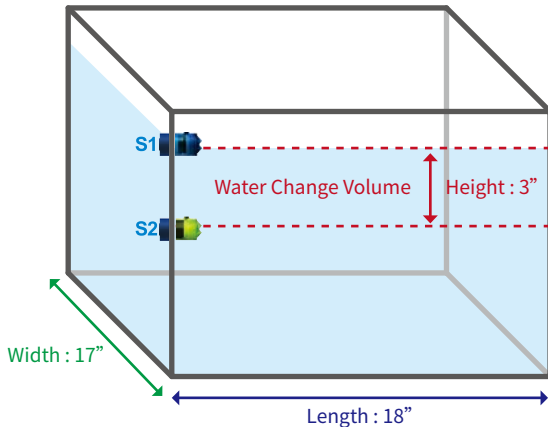

Icons & Buttons for Setting

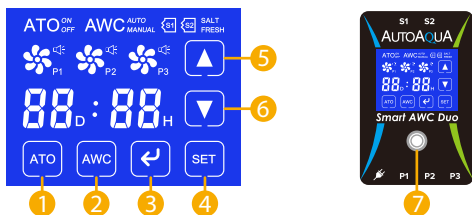

No.	Icon/Button	Function
1		Turn ATO on or off
2		Choose AWC MANUAL / AUTO mode or turn AWC off
3		1. Start / pause / resume the AWC process 2. Dismiss alarm
4		Choose the setting item in the AWC MANUAL / AUTO mode
5		1. Increase day / hour 2. Choose Saltwater / Freshwater mode
6		1. Decrease day / hour 2. Choose Saltwater / Freshwater mode
7		1. Wake up the display 2. Dismiss alarm 3. Resume AWC process 4. Return to AWC setting page* 5. Reset (hold at least for 8 seconds until the display goes black)

*During water change process, pressing can stop the process and return to the previous AWC MANUAL/AUTO setting page. Also, ATO is forced to be turned off if its previous status is on and at the same time the controller gives a five-second audible and visual alert (flashing).

Display Indication

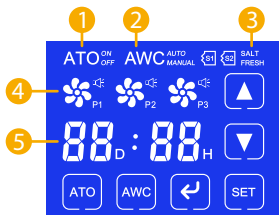









No.	Item	Display
1	ATO	<p>ATO^{ON} : ATO is on.</p> <p>ATO^{OFF} : ATO is off.</p>
2	AWC	<p>AWC : AWC is off.</p> <p>AWC^{MANUAL} : AWC is in MANUAL mode.</p> <p>AWC^{AUTO} : AWC is in AUTO mode.</p>
3	Aquarium Setting Mode	<p>SALT : Saltwater mode</p> <p>FRESH : Freshwater mode</p>
4	Pump	<p> shows : Pump is connected and off.</p> <p> flashes : Pump pauses after power outage.</p> <p> rotates : Pump is on.</p> <p> flashes : Pump pauses.</p> <p> flashes : QST alarm</p>
5	Countdown Timer (AWC AUTO Mode)	<p>00:00 Colon flashes every second : Timer is running.</p> <p>00:00 Colon flashes every 3 seconds : Timer pauses.</p> <p>00:00 D flashes : DAY is being set.</p> <p>00:00 H flashes : HOUR is being set.</p>

Auto Water Change Setting















1. AWC MANUAL Mode (One-Time AWC)

In this mode, users have to manually start the AWC process.

- 1). Touch  until the screen shows .
- 2). Touch  and the  or  will flash. Touch  or  to set it.
- 3). Touch  again to save the setting.
- 4). Touch  to start the water change.

2. AWC AUTO Mode (Periodic AWC)

In this mode, Smart AWC Duo will do water changes periodically.



- 1). Touch  until the screen shows .
- 2). Touch  and the "D" will flash. Touch  or  to set the date.
- 3). Touch  again and the "H" will flash. Touch  or  to set the hour.*
- 4). Touch  again and the  or  will flash. Touch  or  to set it.
- 5). Touch  again to save the setting.
- 6). Touch  to start the countdown timer. As soon as it reaches the end, the next one starts immediately.

* If the display shows 00D : 00H, touching  will go back to date setting.

** The display will go back to standby status without saving any settings if there is no action for 10 seconds during the setting process.



















*** P3 will not show and work in Freshwater mode.





Auto Water Change Process

1. ATO is turned off automatically during the process.
2. Old water in the tank/sump is pumped out until the water level reaches the Low Level AWC Sensor.
3. New water is filled into the tank/sump until the water level reaches the High Level AWC sensor.
4.  flashes for 3 minutes to balance the water level. It will fill new water automatically if the water level drops.
5. When water change is done,  will flash 5 times with 5 beeps.





Alarm and Reminder

Status	Description	Action
 flashes with the audible alert	1. ATO pump is not connected. 2. ATO pump malfunctions.	1. Connect the pump cable. 2. Replace the pump.
 flashes with the audible alert	Quick Security Technology (QST) alarm Please refer to page 13 for further details.	1. Touch  or  to dismiss the alarm. 2. Verify the root cause. <ul style="list-style-type: none"> • Empty Reservoir • Bubble Noise • Sensor is not clean. • Pump Failure
 &  flashes with the audible alert	Pump pauses over 10 minutes.	Touch  or  to dismiss the alarm.*
 &  flashes with the audible alert	Timer pauses over 10 minutes.	Touch  or  to dismiss the alarm.*
 shows	The High Level Failsafe Sensor detects water.**	Touch  or  to dismiss the alarm.
 shows	The Low Level Failsafe Sensor detects no water.**	Touch  or  to dismiss the alarm.

* Touching  or  will dismiss the alarm only. Please touch  or  again to resume the process.

** For very small aquariums, it's normal that the failsafe sensor may be triggered after each filling/draining.

*** If there are two alarms triggered at the same time, touching  or  once will dismiss one alarm only.

Quick Security Technology (QST)

Smart AWC Duo uses QST for real-time protection against any failure situation.*

QST can detect the malfunction of the sensor, the controller, and the empty reservoir to avoid the pump running dry. The controller will give an audible and visual alert when any one of the following situations occurs.

For ATO: Any filling time is 6 times longer than the first filling time. For example, if the first filling time is 10 sec, the controller will give an alert when any filling time is over 60 sec.

For AWC: Any draining time or filling time is 3 times longer than the first one.**

For example, if the first draining or filling time is 20 sec, the controller will give an alert when any draining or filling time is over 60 sec.

*No security time control for the first filling and draining.

**AWC filling time including the filling occurring during 3-minute balance period.

How to Reset / How to Clear QST Memory?

Press  for at least 8 seconds until the display goes black can clear QST memory and go back to factory setting. After reset, please unplug and plug the power cable back in.



Power Outage Security Measures

1. When the power outage occurs during the water change process, the process will be delayed for 1 minute after restoration of power and then resumes. The pump icon will flash during the delay.
2. When the power outage occurs during the countdown, the timer will pause during power outage.* It will retain the record and resume after power outage automatically.

* Since the timer is not running during a power outage, the next water change process will be delayed.

For example, a power outage occurs when the display shows 00:08. After Smart AWC Duo is powered on again, the countdown will start from 00:08.

Specifications

1. Power Input : 100-240 VAC 50-60 Hz
2. DC Pump :
 - Head : 8.2 feet (250 cm)
 - Flow Rate : 74 gph (280 lph)
3. Max. Mounting Thickness : 1/2 inch (12.7 mm)
4. Water Change Interval :
 - Minimum : 1 hour
 - Maximum : 99 days

Notice

1. Please read the manual in detail before installation.
2. If using another ATO instead of the built-in ATO, please turn off your ATO before AWC starts.
3. Avoid setting up the sensors in an area with micro bubbles and direct light.
4. Please keep the controller away from water and make sure the pump connections are dry before plugging in.

Limited Warranty

1. Limited warranty is provided by AUTOAQUA only if your AUTOAQUA Product ("Product") was purchased from an authorized distributor or an authorized reseller.
2. All warranty repairs or replacement are performed by the authorized distributor or authorized reseller in the region where the Product was first shipped by AUTOAQUA.
3. The limited warranty is valid for a period of 2 years under proper installation and normal use from the date of the original purchase listed on the proof of purchase or sales receipt.
4. In the event of a limited warranty claim, proof of purchase or sales receipt (issued to the original purchaser) is required.

Purchase Date

(Y/M/D)

Warranty Period

Two years from the purchase date

Place of Purchase

(Store name, phone, email, address)

Service

AUTOAQUA Technologies Co., Ltd.
7F-7.,NO.229,Fuxing 2nd Rd.,Zhubei
City, Hsinchu County,Taiwan
E-mail : service@autoaqua.com.tw
www.autoaqua.com.tw

* Please go to AUTOAQUA website to get the distributor information.

